

XEROX® PHASER 3100 MFP

TONER CARTRIDGE REMANUFACTURING INSTRUCTIONS



XEROX PHASER 3100 MFP TONER CARTRIDGE

REMANUFACTURING THE XEROX PHASER 3100 TONER CARTRIDGE

By Mike Josiah and the Technical Staff at UniNet

First released in April 2008 the Xerox Phaser 3100 is based on a 20ppm, 600 dpi MFP engine that has a first page out in less than 13 seconds. These machines can print, copy, fax and scan. The printers come with a starter cartridge rated for 2,000 pages and the standard cartridge (106R01379) is rated for 4,000 pages at 5% coverage.



These machines use a somewhat unique method of telling the printer a new cartridge has been installed. Instead of a chip on the cartridge they use a key card that is inserted separately into the printer. These reset cards need to be replaced each cycle. When packaging the cartridge it is a good idea to tape the card to the top of the bag so the user does not forget they have to insert the card for the cartridge to work (just like the OEM does). An interesting item about this system is that the cartridge does not have a toner end detection system. It is all controlled by the reset card.

These cartridges are fairly easy to do, and with a retail cost of \$178.00* very profitable too!

*In U.S. dollars, as of February 2010.

REQUIRED TOOLS

1. Toner approved vacuum
2. A small common screwdriver
3. A Phillips head screwdriver
4. Needle nose pliers
5. Size T-7 Torx driver

REQUIRED SUPPLIES

1. Dedicated Phaser 3100 toner
2. Dedicated Phaser 3100 reset card
3. Conductive grease
4. 99% pure isopropyl alcohol
5. Cotton swabs
6. Soft, lint free wipes

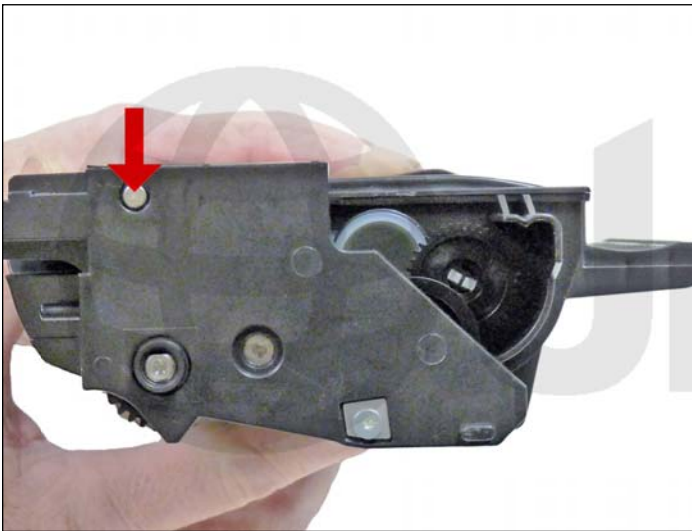

1. Remove the two silver pins, one from each side of the cartridge. Pry them out with a small jeweler's screwdriver and then grab them with wire cutters to remove them.

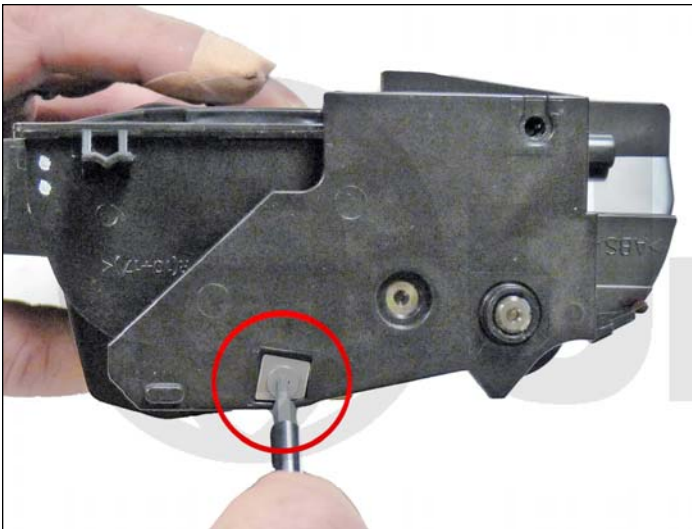

2. Remove the Torx screws and plate from both sides of the cartridge.

The Torx screws used in these cartridges are size T-7.



3. Pry out one of the side panels and separate the two halves.

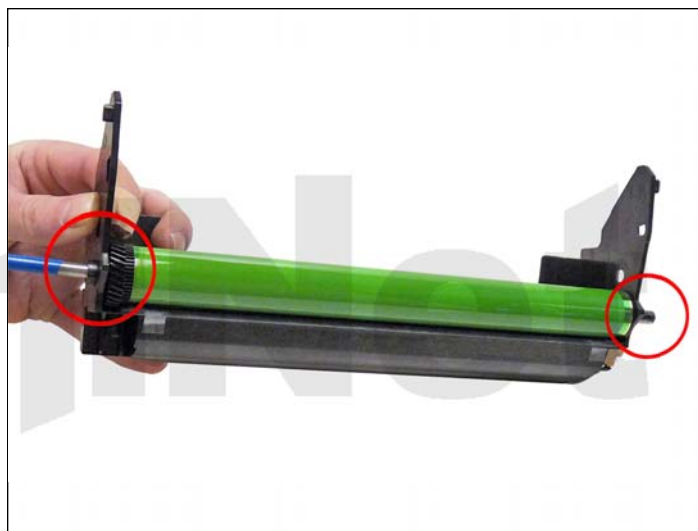

4. From the gear side of the drum section, take a small punch (1/4") or screwdriver and drive the metal axle pin out. This axle is fairly tight. Make sure you do it from the gear side (the keyed side). If you try and drive the axle out from the opposite side, the axle will not move and you may damage the drum ground contact inside the drum. Remove the drum.



5. Remove the PCR and clean with your preferred cleaner.



6. Remove the two screws on the wiper blade and the blade. Clean out the waste chamber. **NOTE:** Be very careful not to damage or distort the thin mylar recovery blade next to the wiper blade. If this blade is bent or damaged in any way, it should be replaced.

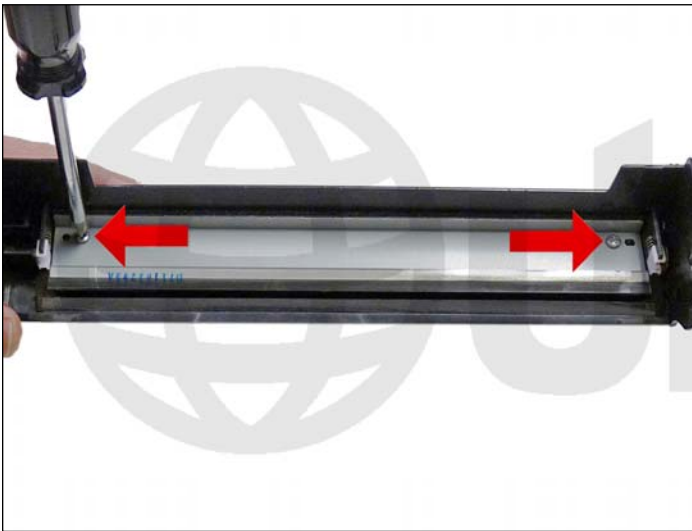

7. Re-install the two screws and the wiper blade.



8. Clean off all the old conductive grease from the PCR contacts and replace with new. Remember: whenever using conductive grease more is never better. Only use a small amount (match what the OEM had there).



9. Install the cleaned PCR.



10. Install the drum into the cartridge.

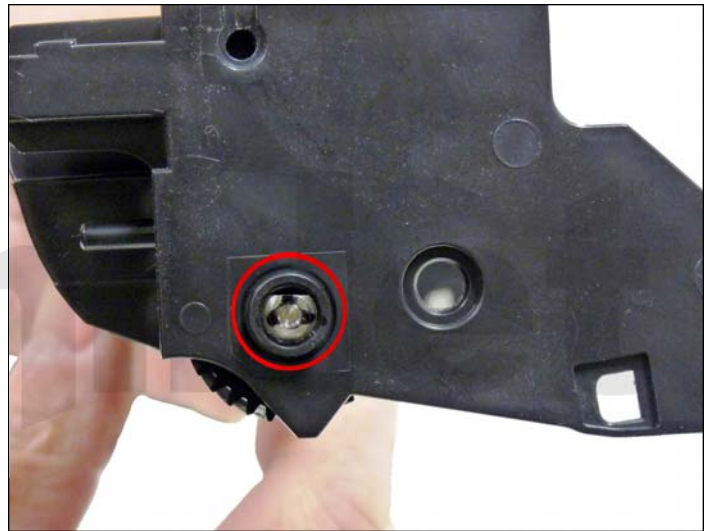
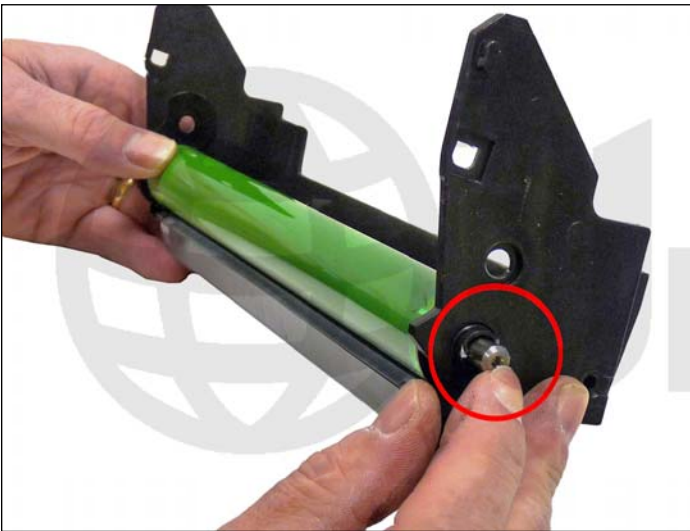

11. Install the drum axle from the hub side. Make sure the keyed end of the axle is installed first. It is easier if you mark the keyed end with a marker so you know how to orientate it when installing it. The side marks in the left photo show the orientation of the flat or keyed edge. The top mark in the right photo shows the keyed edge location.

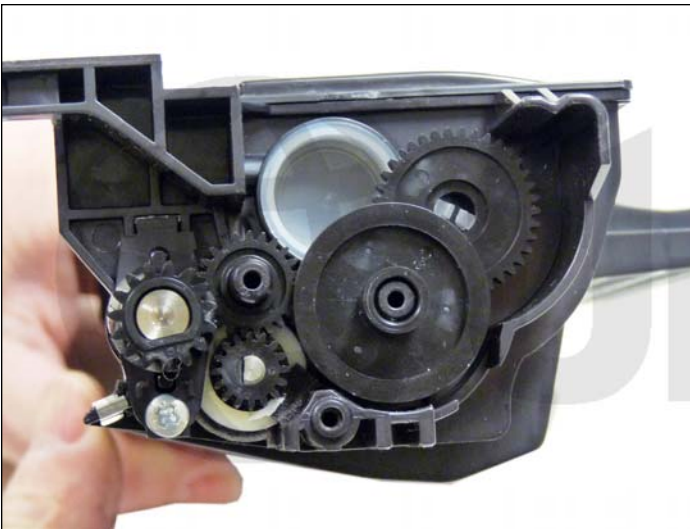

12. On the toner hopper, note the location of all the gears.



13. Remove the four loose gears from the hopper.



14. Remove the gear from the fill plug area by pressing in on the tab.

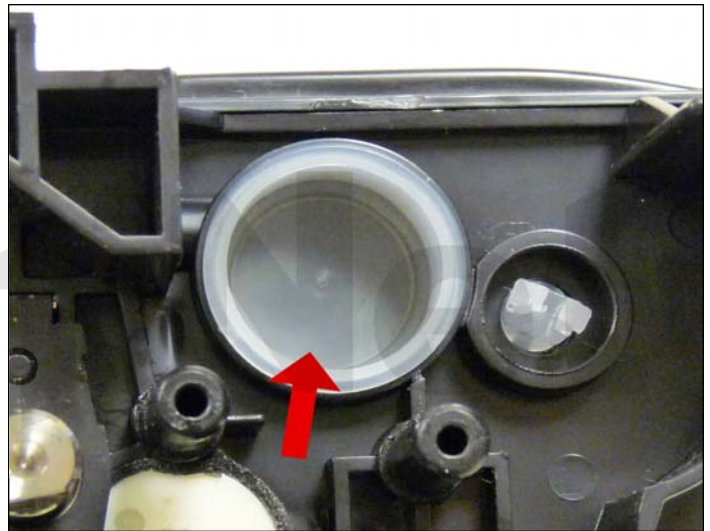

15. Remove the fill plug and dump out any remaining toner from the hopper.

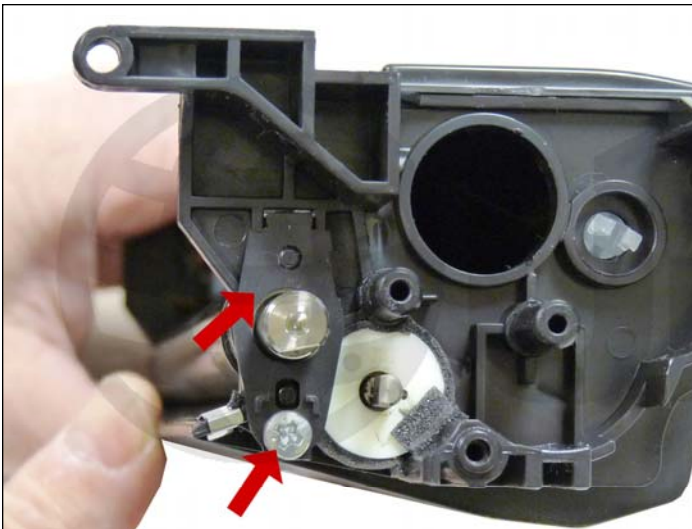

16. Remove the screw and holder from the gear side of the developer roller.

Press in on the plastic tabs on the back side of the holder to remove it.



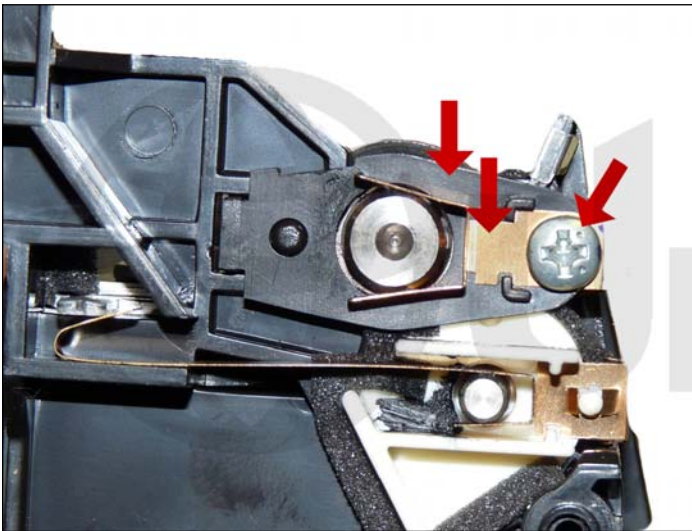

17. Remove the screw, holder and contact from the contact side of the developer roller.

Press in on the plastic tabs on the back side of the holder to remove it. Be careful not to lose the contact!

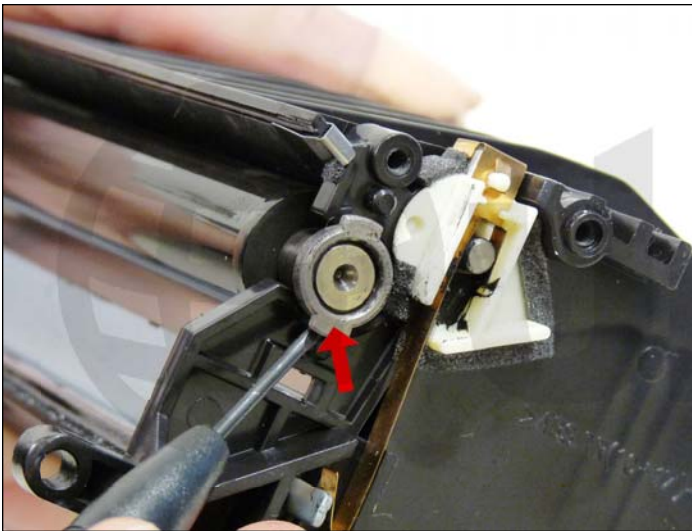

18. Pry off the metal bushings from both sides of the developer roller shaft.

19. Remove the developer roller.



20. Remove the two screws from the doctor blade. **NOTE:** The doctor blade in these cartridges actually consists of three parts. An upper metal brace, the doctor blade itself which is a very thin sheet of metal and the lower metal brace. Be very careful when handling the doctor blade as it is very easily bent.



21. Remove the upper metal brace, being careful not to damage the alignment pins. The pin on the left side is normally tight so more care should be taken there.



22. Remove the doctor blade. Lift it out from the slot on the left side of the hopper. Again, be very careful not to damage it. Clean the blade with a cotton swab and alcohol.

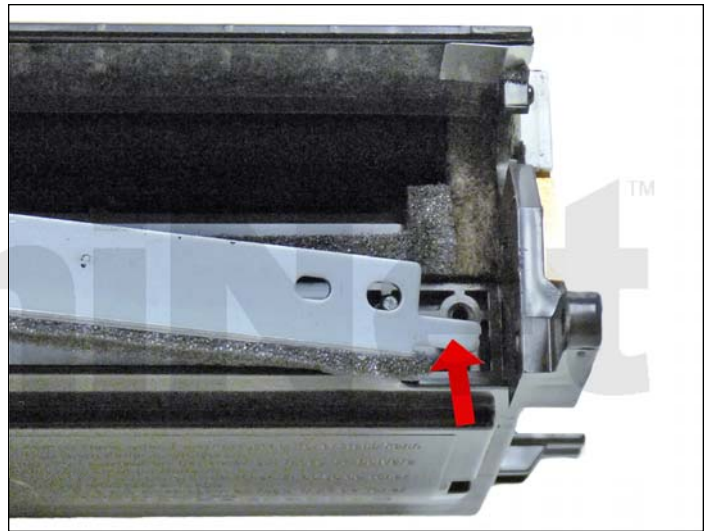

23. Remove the lower metal brace.

Lift it out from the left side as the right side has a tail that runs through the cartridge wall.

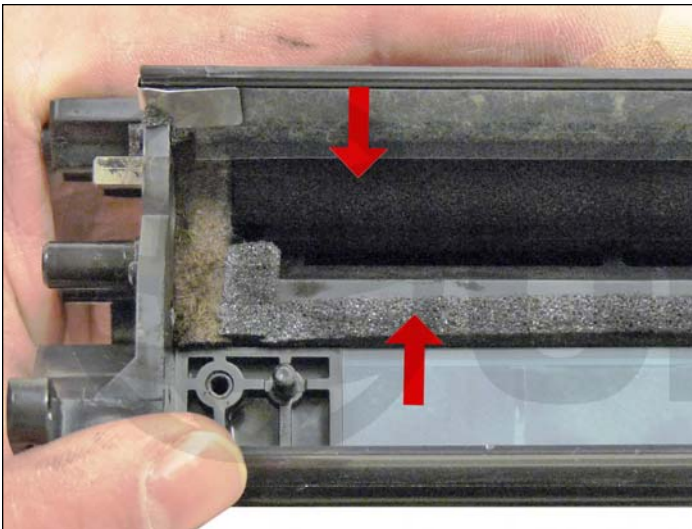

24. Clean out any remaining toner from the hopper. Make sure to get the feed roller and foam seals clean. It is not necessary to remove the roller, just make sure it is clean.



25. Replace the cleaned doctor blade assembly in the hopper. Install the lower brace first inserting the tail through the cartridge wall and under the copper contact. Install the doctor blade next making sure the lip is facing down and the blade fits over the alignment pins correctly.



26. Replace the upper metal brace and the two screws. Clean the developer roller with a clean lint free dry cloth. We do not recommend any chemicals be used at this time.



27. Replace the developer roller into the cartridge. The long metal shaft side goes to the gear side of the hopper.

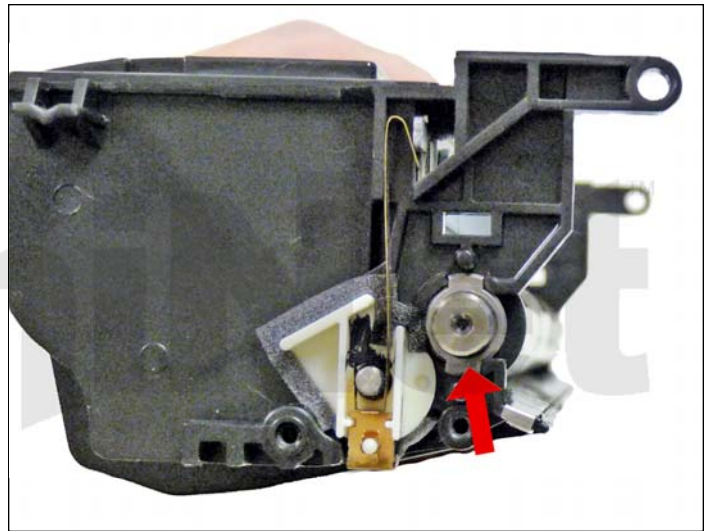

28. Replace the metal bushings on both sides of the developer roller shaft.

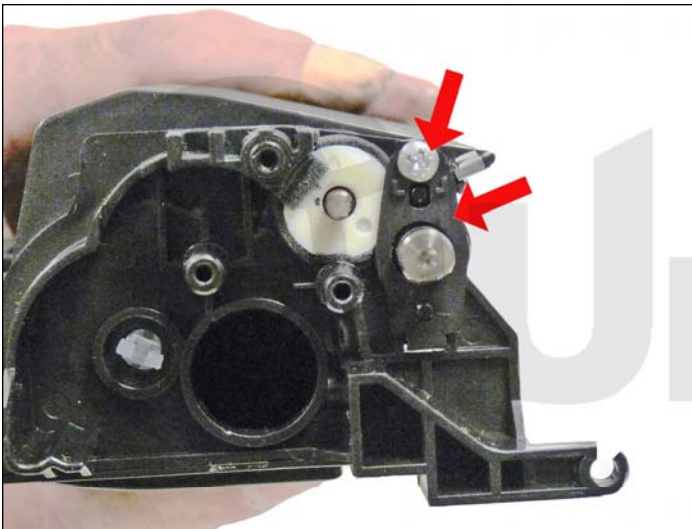

29. Replace the screw and holder on the gear side of the developer roller shaft.

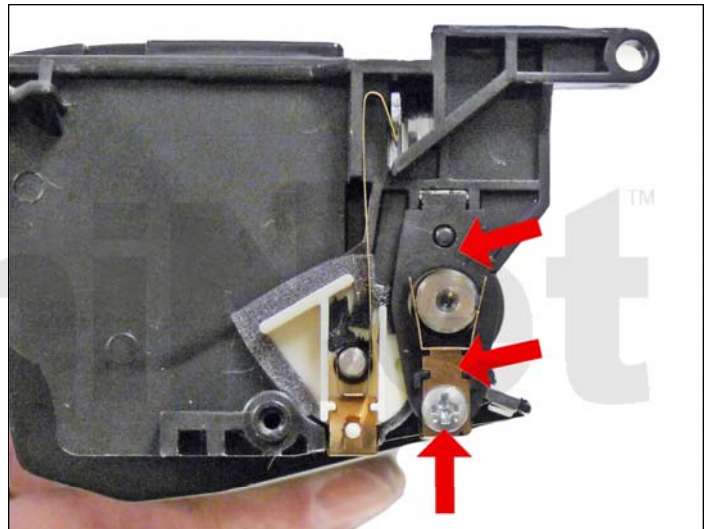

30. Replace the screw, holder and contact on the contact side of the developer roller shaft.

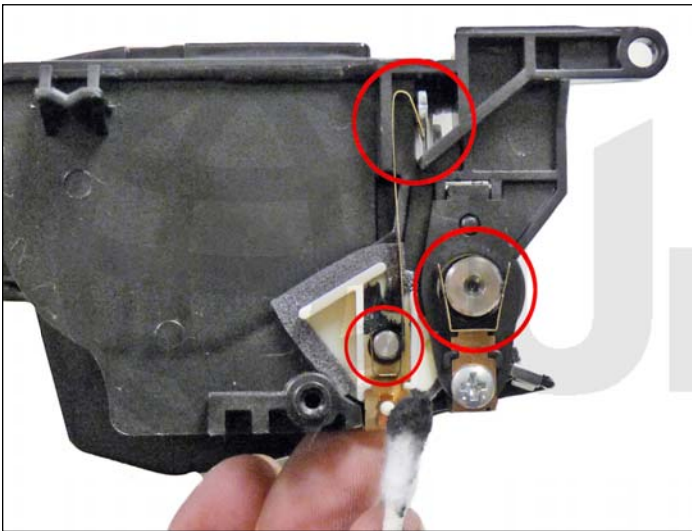

31. Clean and replace the conductive grease on the developer roller and the feed roller shafts. Note that the feed roller contacts also run to the doctor blade. This helps ensure that the toner is properly charged throughout the hopper.



32. Fill the hopper with the Phaser 3100 toner.

Replace the fill plug.

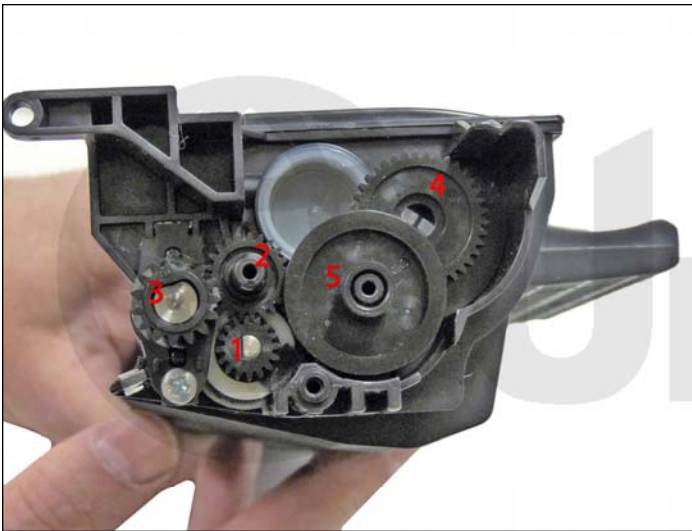

33. Replace all the gears on the hopper as shown.

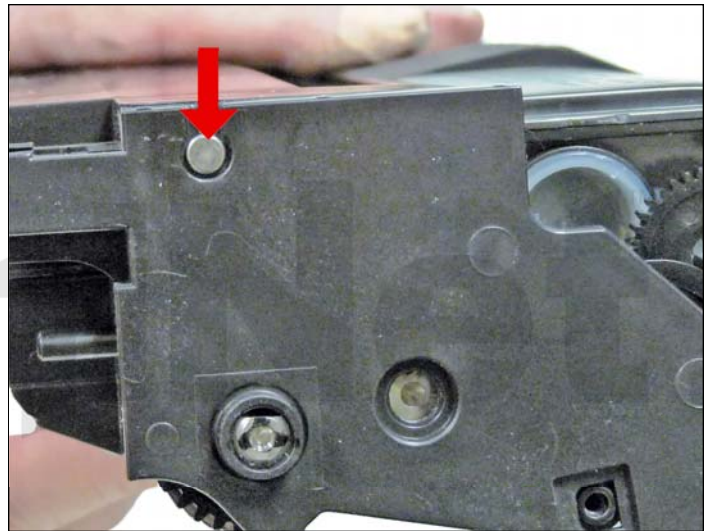

34. Place the two halves together and install the two metal pins.



35. Install the metal plates and screws.

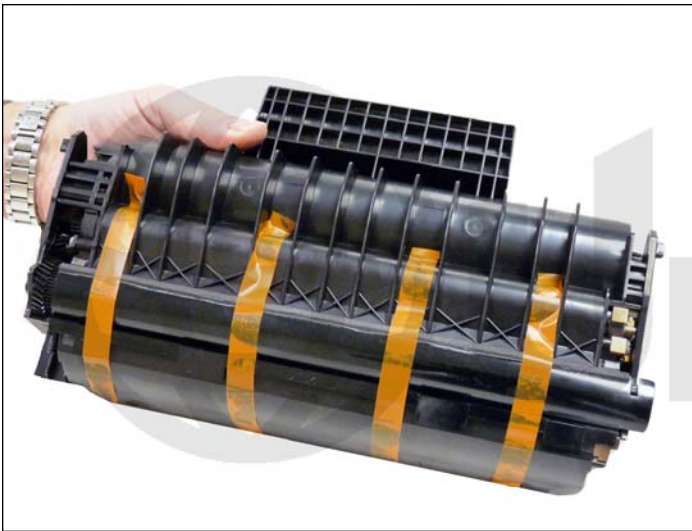

36. Install the drum cover if available. It needs to be taped in place. Use a brightly colored tape so the user will notice it.



37. After the cartridge has been tested and bagged, tape the Key card to the top of the bag so the user will see it. This key card is installed into the printer separately from the cartridge.

PRINTING A TEST PAGE:

The simplest way to test a cartridge is to make a copy:

1. To do this place the original face down in the feeder.
2. Press the copy key, number of copies desired and the start key.

CLEANING THE SCANNER:

If copied and transmitted pages come out with marks on the pages, but the reports are clean, the scanner is dirty:

1. To clean the scanner, open the scanner cover.
2. Wipe the scanner window down with a lint free cloth moistened with Isopropyl alcohol.

REPETITIVE DEFECT CHART:

OPC Drum	75mm
Developer Roller	50mm
PCR	29mm